

Electronic 0-10V Dimmable 60W and 96W LineDRIVE Power Supply Specification Sheet



Project Name	Type
Catalog #	Date

PRODUCT OVERVIEW

GM Lighting's LineDRIVE 0-10V dimmable 60W and 96W LED driver is a compact and light weight powerhouse that features high efficiency that reduces total power consumption.



FEATURES

- 120V/277V input
- Soft start feature
- Constant voltage output - 0-10V dimming (switch by others)
- Overload / short circuit / over-voltage / thermal protection
- High efficiency to reduce total power consumption
- Compact size and light weight
- Indoor only
- Recommended load: min. 40% to max. 85% for optimal performance
- 5 year warranty



SPECIFICATIONS

ELECTRICAL

- 12V/24VDC
- 120/277VAC
- 60W or 96W

HOUSING

- Black powder coated steel enclosure
- Cooling by free-air convection

ENVIRONMENT

- Store in a dry location

OPERATING TEMP

- -40 to 140°F (-40 to +60°C)

CERTIFICATION

- UL certified
- Cert. CSA C22.2 No. 250.2
- Class 2

PROTECTION

- Hiccup mode, recover automatically after fault condition is removed

WARRANTY

- 5-year warranty

ORDERING INFORMATION

Example: LD-ED010-UNV60-12

Model	Series	Type	Watts	Voltage
LD	ED010	UNV	60	12
LD	ED010	UNV	96	24

Electronic 0-10V Dimmable

60W and 96W LineDRIVE

Power Supply Specification Sheet

Model	Output	Input	Power Factor	Efficiency	Weight	Size (L*W*H)
LD-ED010-UNV60-12	12V / 60W / 5A	0.63A@120V 0.35A@240V 0.30A@277V	> 0.94	120V / 81% 240V / 84% 277V / 86%	1.5lbs (700g)	7.93"L x 3.35"W x 1.32"H (201.4*85*33.6mm)
LD-ED010-UNV96-24	24V / 96W / 4A	0.98A@120V 0.52A@240V 0.45A@277V		120V / 85% 240V / 88% 277V / 89%	2.2lbs (1000g)	8.25"L x 4.10"W x 1.56"H (209.6*104.1*39.7mm)

DIMENSION

LD-ED010-UNV60-12

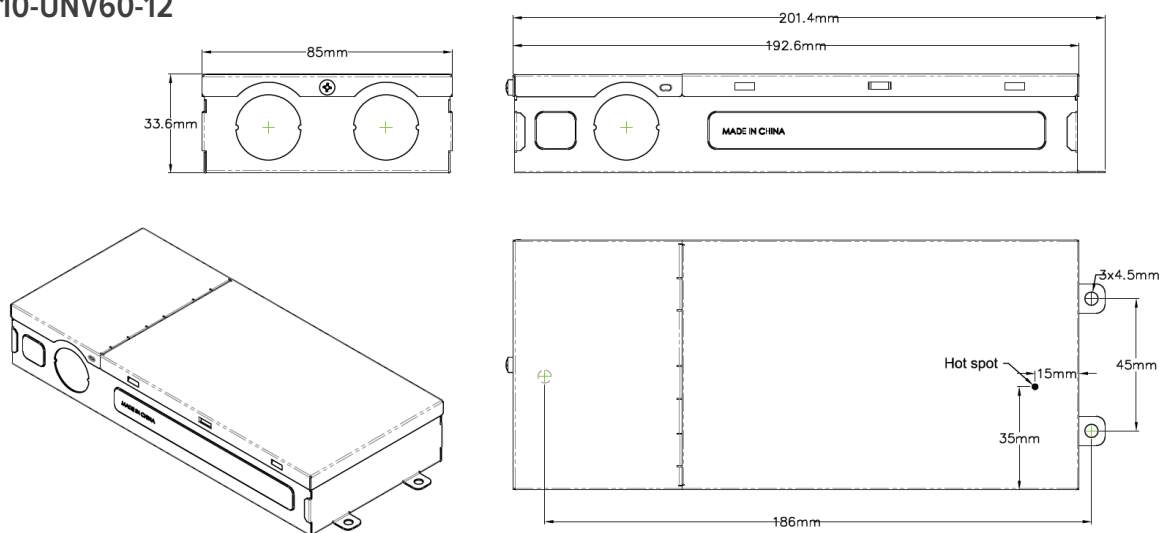

LD-ED010-UNV96-24

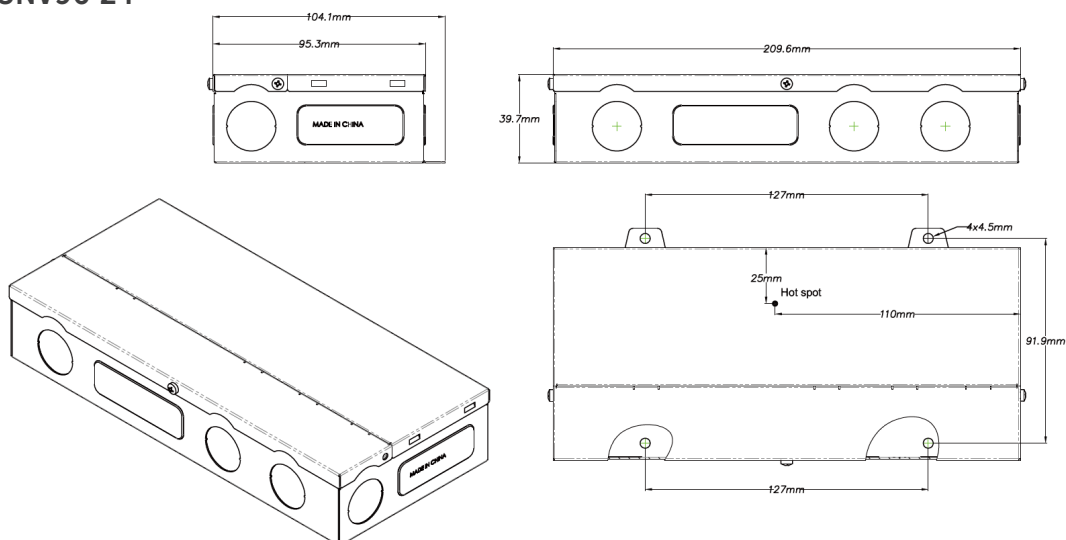

Electronic 0-10V Dimmable

60W and 96W LineDRIVE Power Supply Specification Sheet

WIRING DIAGRAM

LD-ED010-UNV60-12

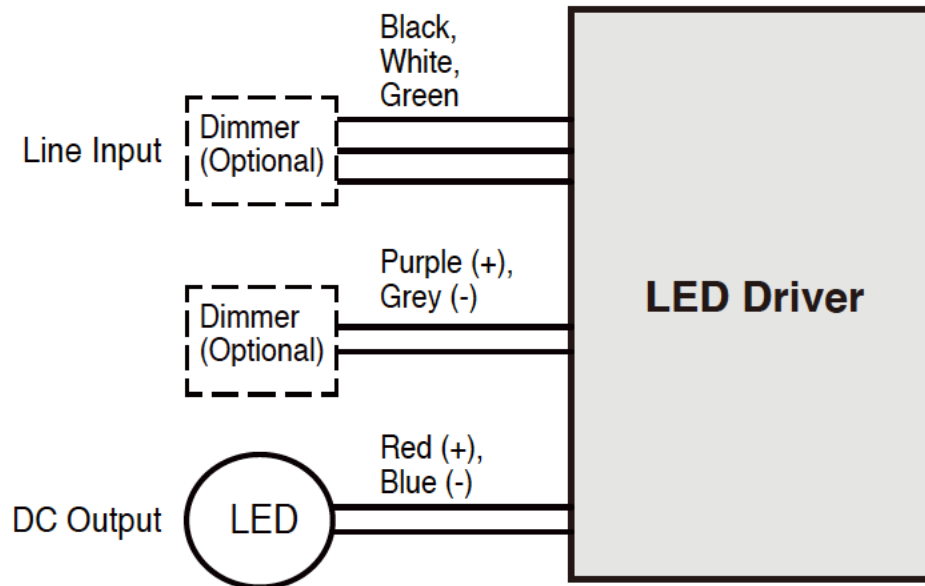

LD-ED010-UNV96-24

